



SPECIFICATION

OLED SPECIFICATION

Model No:

REX012832GWAP3N00000

CUSTOMER:

APPROVED BY	
PCB VERSION	
DATE	

FOR CUSTOMER USE ONLY

SALES BY	APPROVED BY	CHECKED BY	PREPARED BY

APPROVAL FOR SPECIFICATIONS ONLY

APPROVAL FOR SPECIFICATIONS AND SAMPLE

1. Revision History

VERSION	DATE	REVISED PAGE NO.	Note
0	2018/04/09		First release
A	2018/11/27		Modify Static electricity test Content of Test
B	2019/09/02		Modify Precautions in use of OLED Modules
C	2019/12/18		Modify Reliability Test measurement conditions & Inspection specification: " Accept no dense" modify to "ignore"& Precautions &Interface Pin Function

Contents

- 1.General Specification
- 2.Module Classification Information
- 3.Interface Pin Function
- 4.Contour Drawing & Block Diagram
- 5.Absolute Maximum Ratings
- 6.Electrical Characteristics
- 7.Optical Characteristics
- 8.OLED Lifetime
- 9.Reliability
- 10.Inspection specification
- 11.Precautions in use of OLED Modules

1. General Specification

The Features is described as follow:

- Module dimension: 50.50 x 15.75 x 2.01 mm
- Active area: 42.22 x 10.54 mm
- Dot Matrix: 128 x 32
- Pixel size: 0.308 x 0.308 mm
- Pixel pitch: 0.33 x 0.33 mm
- Display Mode: Passive Matrix
- Duty: 1/32 Duty
- Display Color: White
- IC: SSD1307
- Interface: SPI,I2C
- Size: 1.71 inch

2.Module Classification information

1	2	3	4	5	6	7	8	9	10	11	12	13	14
R	E	X	012832	G	W	A	P	3	N	0	0	0	00

1	Brand : Raystar Optronics Inc.			
2	E : OLED			
3	Display Type	C : COB Character		G : COB Graphic
		X : COG		H : COG + FR
		P : COG + FR + PCB		T : TAB
		A : COG + PCB		
4	Dot Matrix : 128*32			
5	Series			
6	Emitting Color	A : Amber	R : Red	C : Full Color
		B : Blue	W : White	
		G : Green	Y : Yellow	
		S : Sky Blue	X : Dual Color	
7	Polarizer	P : With Polarizer; N: Without Polarizer A : Anti-glare Polarizer		
8	Display Mode	P : Passive Matrix ; N : Active Matrix		
9	Driver Voltage	3 : 3.0~3.3V ; 5 : 5.0V		
10	Touch Panel	N : Without touch panel; T: With touch panel		
11	Product type	0 : Standard 1 : Daylight Readable 2 : Transparent OLED (TOLED) 3 : Flexible OLED (FOLED) 4 : OLED Lighting		
12	Inspection Grade	0 : Standard 2 : B grade C : Automotive grade Y : Consumer grade		
13	Option	0 : Default ; F : ZIF FPC ; H : Hot bar FPC; D : Demo Kit		
14	Serial No.	Serial number(00~ZZ)		

3.Interface Pin Function

No.	Symbol	Function
1	N.C. (GND)	Dummy Pin This is dummy pin. Do not group or short NC pins together.
2	VCC	Power supply for panel driving voltage. This is also the most positive power voltage supply pin.
3	VLSS	This is an analog ground pin. It should be connected to VSS externally
4	VSS	This is a ground pin.
5	VDD	Power Supply for Logic
6	CS#	The chip select input. (active LOW)
7	RES#	Power Reset for Controller and Driver
8	D/C#	This is Data/Command control pin. When it is pulled HIGH (i.e. connect to VDD), the data at D[7:0] is treated as data. When it is pulled LOW, the data at D[7:0] will be transferred to the command register. In I2C mode, this pin acts as SA0 for slave address selection. When 3-wire serial interface is selected, this pin must be connected to VSS.
9~11	D0~D2	Host Data Input / Output Bus When serial interface mode is selected, D0 will be the serial clock input: SCLK; D1 will be the serial data input: SDIN and D2 should be kept NC. When I2C mode is selected, D2, D1 should be tied together and serve as SDAout, SDAin in application and D0 is the serial clock input, SCL.
12	IREF	This is segment output current reference pin. A resistor should be connected between this pin and VSS to maintain the IREF current at 10uA.
13	VCOMH	The pin is for COM signal deselected voltage level. A capacitor should be connected between this pin and VSS.
14	VCC	Power supply for panel driving voltage. This is also the most positive power voltage supply pin.



15,16	BS0 BS1	Communicating Protocol Select These pins are MCU interface selection input. See the following table:		
			BS0	BS1
		I2C	0	1
		3-wire SPI	1	0
	4-wire SPI	0	0	
		Note (1) 0 is connected to VSS (2) 1 is connected to VDD		
17	VLSS	This is an analog ground pin. It should be connected to VSS externally.		
18	N.C. (GND)	Dummy Pin This is dummy pin. Do not group or short NC pins together.		

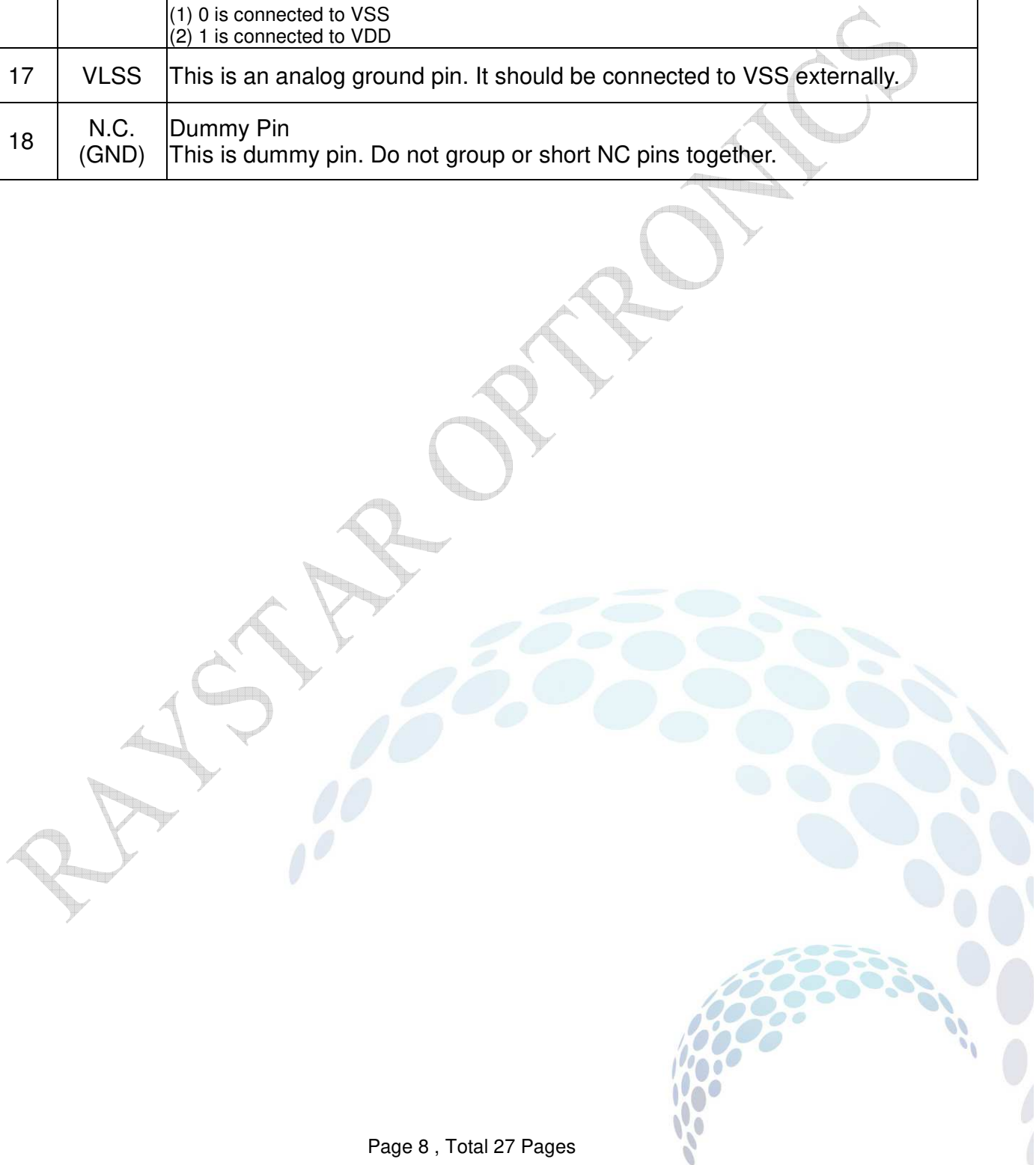

4. Contour Drawing & Block Diagram

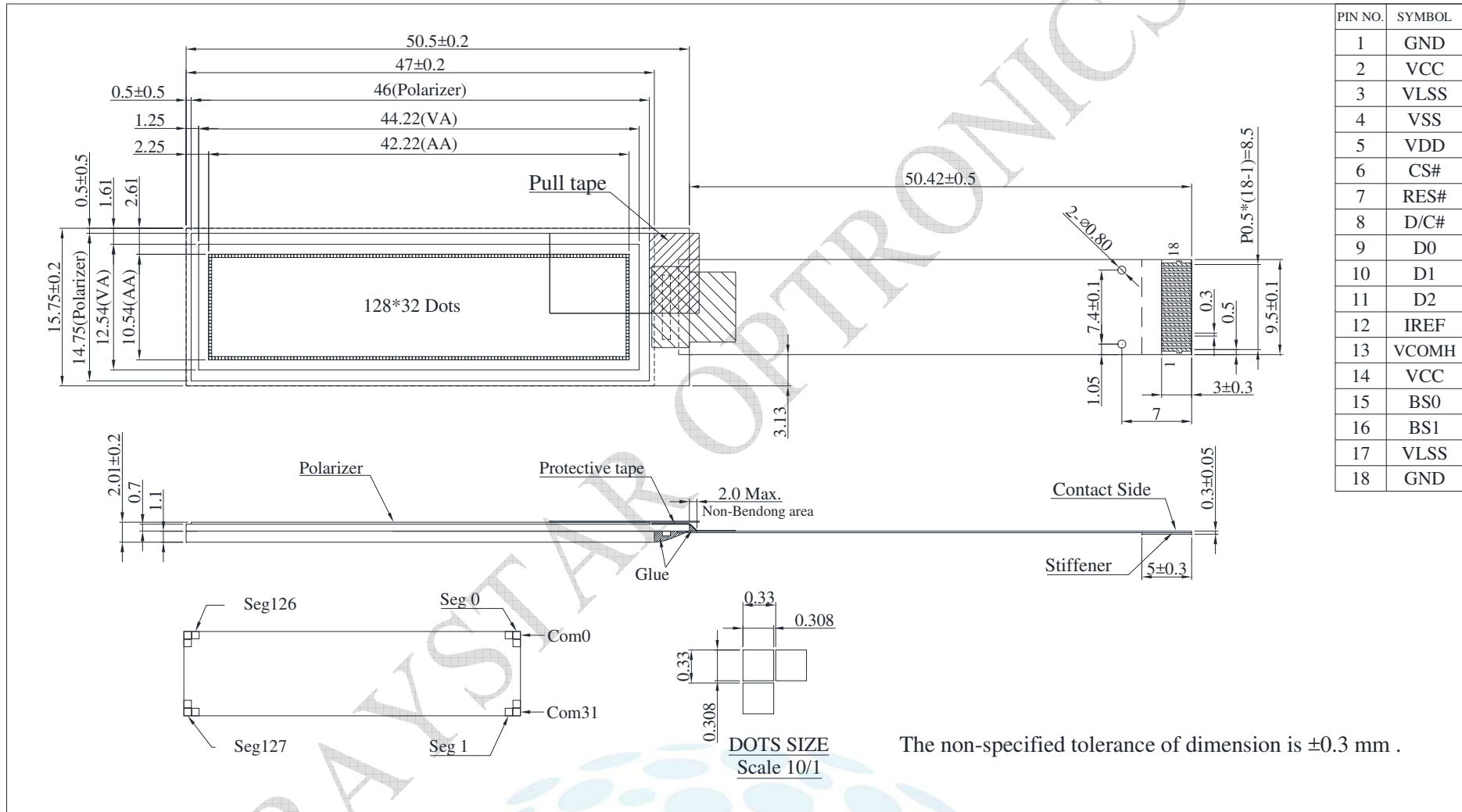



4.1 Application recommendations

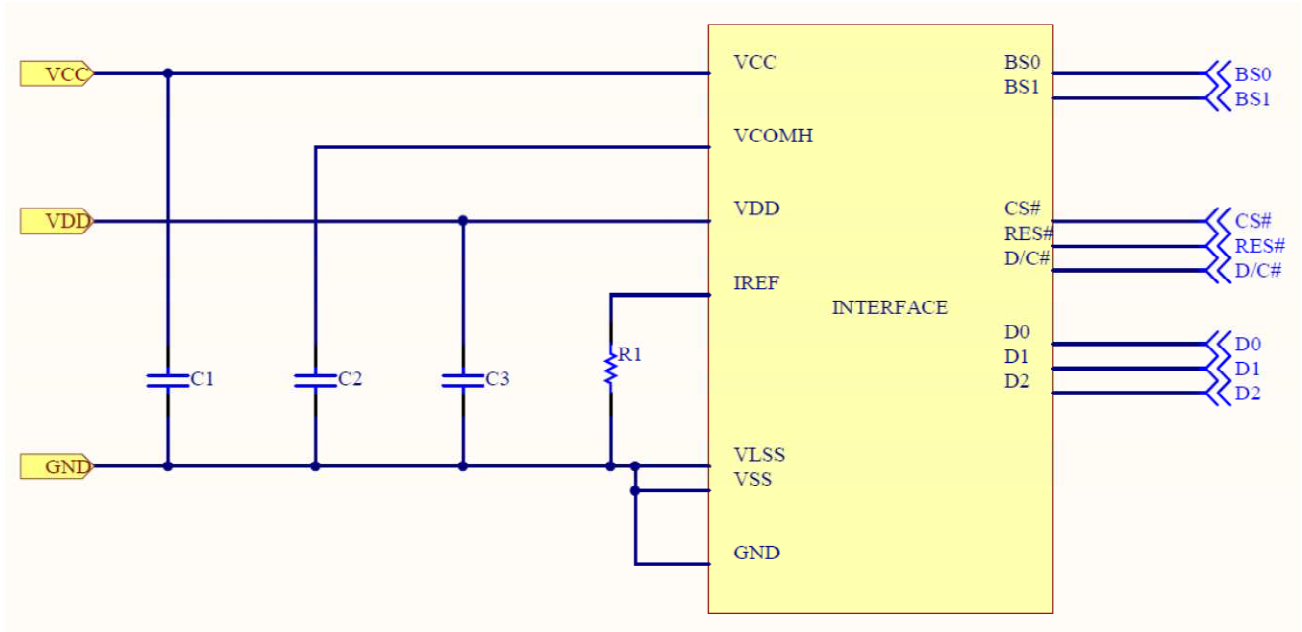

Recommended components :

C2, C3 : 2.2uF

C1 : 1.0uF

Bus Interface selection: (Must be set the BS[2:0], refer to item 4)
3 or 4-wire SPI, and I2C

Voltage at IREF = VCC – 3V. For VCC = 12V, IREF = 10uA:

$R1 = (\text{Voltage at IREF} - VSS) / IREF$

= (12-3) / 10u

= 900K ohm

*For more information, please refer to Application Note provided by Raystar Optonics.



5. Absolute Maximum Ratings

Parameter	Symbol	Min	Max	Unit	Notes
Supply Voltage for Logic	VDD	-0.3	4.0	V	1,2
Supply Voltage for Display	VCC	0	16.0	V	1,2
Operating Temperature	TOP	-40	+80	°C	—
Storage Temperature	TSTG	-40	+85	°C	—

Note 1: All the above voltages are on the basis of “VSS = 0V”.

Note 2: When this module is used beyond the above absolute maximum ratings, permanent breakage of the module may occur. Also, for normal operations, it is desirable to use this module under the conditions according to Section 6. “Optics & Electrical Characteristics”. If this module is used beyond these conditions, malfunctioning of the module can occur and the reliability of the module may deteriorate.

6. Electrical Characteristics

6.1 DC Electrical Characteristics

Item	Symbol	Condition	Min	Typ	Max	Unit
Supply Voltage for Logic	VDD	—	2.8	3.0	3.3	V
Supply Voltage for Display	VCC	—	11.5	12.0	12.5	V
High Level Input	VIH	—	0.8×VDD	—	—	V
Low Level Input	VIL	—	0	—	0.2×VDD	V
High Level Output	VOH	—	0.9×VDD	—	—	V
Low Level Output	VOL	—	—	—	0.1×VDD	V
Operating Current for VCC (Full ON)	ICC	VCC=12.0V	—	14.5	19.0	mA



6.2 Initial code

```
void Initial_SSD1307ZD(void){  
  
    Write_command(0xAE); // Display Off  
  
    Write_command(0xD5); //SET DISPLAY CLOCK  
    Write_command(0x80); //  
  
    Write_command(0xA8); // Select Multiplex Ratio  
    Write_command(0x1F); // Default => 0x3F (1/64 Duty)    0x1F(1/32 Duty)  
  
    Write_command(0xD3); //Setting Display Offset  
    Write_command(0x00); //00H Reset  
  
    Write_command(0x40); //Set Display Start Line  
  
    Write_command(0xA1); //Set Segment Re-Map Default  
                        //0xA0 (0x00) => column Address 0 mapped to 127  
                        //0xA1 (0x01) => Column Address 127 mapped to 0  
  
    Write_command(0xC0); //Set COM Output Scan Direction  
  
    Write_command(0xDA); //Set COM Hardware Configuration  
    Write_command(0x12); //Alternative COM Pin---See IC Spec page 34  
  
    Write_command(0x81); //Set Contrast Control  
    Write_command(0x48);  
  
    Write_command(0xD9); //Set Pre-Charge period  
    Write_command(0xA1);  
  
    Write_command(0xDB); //Set Deselect Vcomh level  
    Write_command(0x00);  
  
    Write_command(0xA4); //Entire Display ON  
  
    Write_command(0xA6); //Set Normal Display  
  
    Write_command(0xAF); // Display ON  
  
}
```

7.Optical Characteristics

Item	Symbol	Condition	Min	Typ	Max	Unit
View Angle	(V) θ	—	160	—	—	deg
	(H) ϕ	—	160	—	—	deg
Contrast Ratio	CR	Dark	2000:1	—	—	—
Response Time	T rise	—	—	10	—	μ s
	T fall	—	—	10	—	μ s
Display with 100% check Board Brightness			80	100	—	cd/m ²
CIEx(White)		(CIE1931)	0.26	0.28	0.30	—
CIEy(White)		(CIE1931)	0.30	0.32	0.34	—

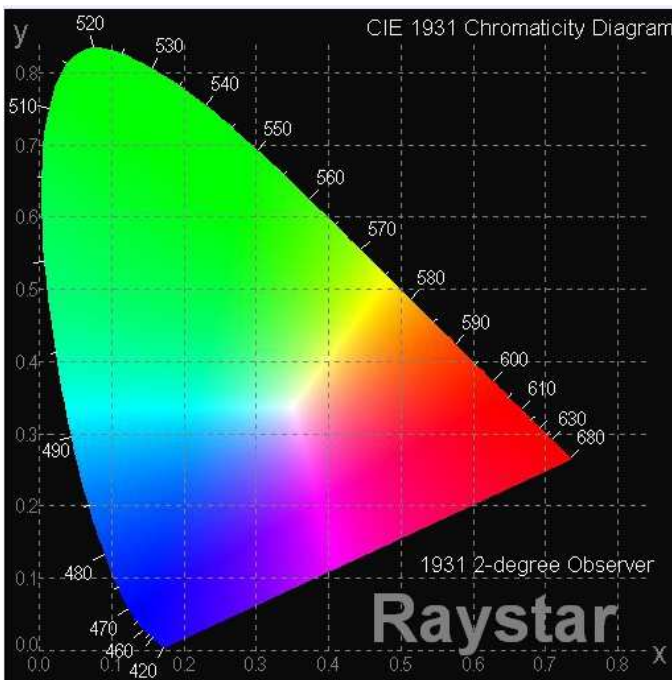



8.OLED Lifetime

ITEM	Conditions	Min	Typ	Remark
Operating Life Time	Ta=25°C / Initial 50% check board brightness Typical Value	20,000 Hrs	-	Note

Notes:

1. Life time is defined the amount of time when the luminance has decayed to <50% of the initial value.
2. This analysis method uses life data obtained under accelerated conditions to extrapolate an estimated probability density function (*pdf*) for the product under normal use conditions.
3. Screen saving mode will extend OLED lifetime.

9. Reliability

Content of Reliability Test

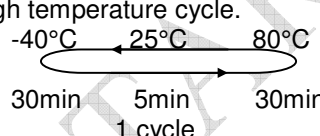
Environmental Test			
Test Item	Content of Test	Test Condition	Applicable Standard
High Temperature storage	Endurance test applying the high storage temperature for a long time.	85°C 240hrs	—
Low Temperature storage	Endurance test applying the low storage temperature for a long time.	-40°C 240hrs	—
High Temperature Operation	Endurance test applying the electric stress (Voltage & Current) and the thermal stress to the element for a long time.	80°C 240hrs	—
Low Temperature Operation	Endurance test applying the electric stress under low temperature for a long time.	-40°C 240hrs	—
High Temperature/ Humidity Storage	Endurance test applying the high temperature and high humidity storage for a long time.	60°C, 90%RH 240hrs	—
High Temperature/ Humidity Operation	Endurance test applying the high temperature and high humidity Operation for a long time.	60°C, 90%RH 120hrs	—
Temperature Cycle	Endurance test applying the low and high temperature cycle. 	-40°C / 80°C 30 cycles	—
Mechanical Test			
Vibration test	Endurance test applying the vibration during transportation and using.	Frequency: 10~55Hz amplitude: 1.5mm Time: 0.5hrs/axis Test axis: X, Y, Z	—
Others			
Static electricity test	Endurance test applying the electric stress to the finished product housing.	Air Discharge model ±4kv, 10 times	—

*** Supply voltage for OLED system = Operating voltage at 25°C



Test and measurement conditions

1. All measurements shall not be started until the specimens attain to temperature stability. After the completion of the described reliability test, the samples were left at room temperature for 2 hrs prior to conducting the failure test at $23\pm 5^{\circ}\text{C}$; $55\pm 15\%$ RH.
2. All-pixels on/off exchange is used as operation test pattern.
3. The degradation of Polarizer are ignored for High Temperature storage, High Temperature/ Humidity Storage, Temperature Cycle

Evaluation criteria

1. The function test is OK.
2. No observable defects.
3. Luminance: $> 50\%$ of initial value.
4. Current consumption: within $\pm 50\%$ of initial value.

APPENDIX:

RESIDUE IMAGE

Because the pixels are lighted in different time, the luminance of active pixels may reduce or differ from inactive pixels. Therefore, the residue image will occur. To avoid the residue image, every pixel needs to be lighted up uniformly.

RAYSTAR OPTROEONICS

10. Inspection specification

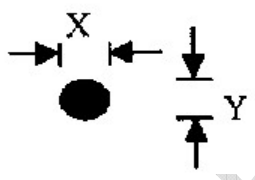
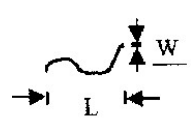
NO	Item	Criterion	AQL												
01	Electrical Testing	1.1 Missing vertical, horizontal segment, segment contrast defect. 1.2 Missing character , dot or icon. 1.3 Display malfunction. 1.4 No function or no display. 1.5 Current consumption exceeds product specifications. 1.6 OLED viewing angle defect. 1.7 Mixed product types. 1.8 Contrast defect.	0.65												
02	Black or white spots on OLED (display only)	2.1 White and black spots on display $\leq 0.25\text{mm}$, no more than three white or black spots present. 2.2 Densely spaced: No more than two spots or lines within 3mm.	2.5												
03	OLED black spots, white spots, contamination (non-display)	3.1 Round type : As following drawing $\Phi = (x + y) / 2$  <table border="1" data-bbox="790 1041 1332 1254"> <thead> <tr> <th>SIZE</th> <th>Acceptable QTY</th> </tr> </thead> <tbody> <tr> <td>$\Phi \leq 0.10$</td> <td>ignore</td> </tr> <tr> <td>$0.10 < \Phi \leq 0.20$</td> <td>2</td> </tr> <tr> <td>$0.20 < \Phi \leq 0.25$</td> <td>1</td> </tr> <tr> <td>$0.25 < \Phi$</td> <td>0</td> </tr> </tbody> </table>	SIZE	Acceptable QTY	$\Phi \leq 0.10$	ignore	$0.10 < \Phi \leq 0.20$	2	$0.20 < \Phi \leq 0.25$	1	$0.25 < \Phi$	0	2.5		
		SIZE	Acceptable QTY												
$\Phi \leq 0.10$	ignore														
$0.10 < \Phi \leq 0.20$	2														
$0.20 < \Phi \leq 0.25$	1														
$0.25 < \Phi$	0														
3.2 Line type : (As following drawing)  <table border="1" data-bbox="670 1344 1332 1556"> <thead> <tr> <th>Length</th> <th>Width</th> <th>Acceptable Q TY</th> </tr> </thead> <tbody> <tr> <td>---</td> <td>$W \leq 0.02$</td> <td>ignore</td> </tr> <tr> <td>$L \leq 3.0$</td> <td>$0.02 < W \leq 0.03$</td> <td rowspan="2">2</td> </tr> <tr> <td>$L \leq 2.5$</td> <td>$0.03 < W \leq 0.05$</td> </tr> <tr> <td>---</td> <td>$0.05 < W$</td> <td>As round type</td> </tr> </tbody> </table>	Length	Width	Acceptable Q TY	---	$W \leq 0.02$	ignore	$L \leq 3.0$	$0.02 < W \leq 0.03$	2	$L \leq 2.5$	$0.03 < W \leq 0.05$	---	$0.05 < W$	As round type	2.5
Length	Width	Acceptable Q TY													
---	$W \leq 0.02$	ignore													
$L \leq 3.0$	$0.02 < W \leq 0.03$	2													
$L \leq 2.5$	$0.03 < W \leq 0.05$														
---	$0.05 < W$	As round type													
04	Polarizer bubbles	If bubbles are visible, judge using black spot specifications, not easy to find, must check in specify direction. <table border="1" data-bbox="813 1601 1332 1848"> <thead> <tr> <th>Size Φ</th> <th>Acceptable Q TY</th> </tr> </thead> <tbody> <tr> <td>$\Phi \leq 0.20$</td> <td>ignore</td> </tr> <tr> <td>$0.20 < \Phi \leq 0.50$</td> <td>3</td> </tr> <tr> <td>$0.50 < \Phi \leq 1.00$</td> <td>2</td> </tr> <tr> <td>$1.00 < \Phi$</td> <td>0</td> </tr> <tr> <td>Total Q TY</td> <td>3</td> </tr> </tbody> </table>	Size Φ	Acceptable Q TY	$\Phi \leq 0.20$	ignore	$0.20 < \Phi \leq 0.50$	3	$0.50 < \Phi \leq 1.00$	2	$1.00 < \Phi$	0	Total Q TY	3	2.5
Size Φ	Acceptable Q TY														
$\Phi \leq 0.20$	ignore														
$0.20 < \Phi \leq 0.50$	3														
$0.50 < \Phi \leq 1.00$	2														
$1.00 < \Phi$	0														
Total Q TY	3														
05	Scratches	Follow NO.3 OLED black spots, white spots, contamination.													

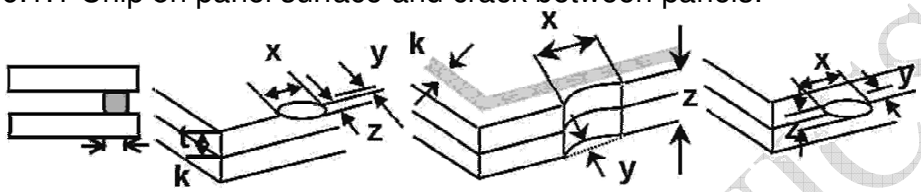
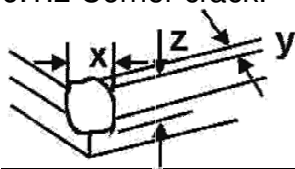
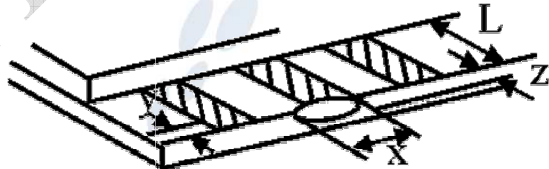
NO	Item	Criterion	AQL																		
06	Chipped glass	<p>Symbols Define: x: Chip length y: Chip width z: Chip thickness k: Seal width t: Glass thickness a: OLED side length L: Electrode pad length: 6.1 General glass chip : 6.1.1 Chip on panel surface and crack between panels:</p>  <table border="1" data-bbox="406 795 1292 929"> <tr> <td>z: Chip thickness</td> <td>y: Chip width</td> <td>x: Chip length</td> </tr> <tr> <td>$Z \leq 1/2t$</td> <td>Not over viewing area</td> <td>$x \leq 1/8a$</td> </tr> <tr> <td>$1/2t < z \leq 2t$</td> <td>Not exceed 1/3k</td> <td>$x \leq 1/8a$</td> </tr> </table> <p>⊙ If there are 2 or more chips, x is total length of each chip.</p> <p>6.1.2 Corner crack:</p>  <table border="1" data-bbox="406 1198 1316 1321"> <tr> <td>z: Chip thickness</td> <td>y: Chip width</td> <td>x: Chip length</td> </tr> <tr> <td>$Z \leq 1/2t$</td> <td>Not over viewing area</td> <td>$x \leq 1/8a$</td> </tr> <tr> <td>$1/2t < z \leq 2t$</td> <td>Not exceed 1/3k</td> <td>$x \leq 1/8a$</td> </tr> </table> <p>⊙ If there are 2 or more chips, x is the total length of each chip.</p>	z: Chip thickness	y: Chip width	x: Chip length	$Z \leq 1/2t$	Not over viewing area	$x \leq 1/8a$	$1/2t < z \leq 2t$	Not exceed 1/3k	$x \leq 1/8a$	z: Chip thickness	y: Chip width	x: Chip length	$Z \leq 1/2t$	Not over viewing area	$x \leq 1/8a$	$1/2t < z \leq 2t$	Not exceed 1/3k	$x \leq 1/8a$	2.5
z: Chip thickness	y: Chip width	x: Chip length																			
$Z \leq 1/2t$	Not over viewing area	$x \leq 1/8a$																			
$1/2t < z \leq 2t$	Not exceed 1/3k	$x \leq 1/8a$																			
z: Chip thickness	y: Chip width	x: Chip length																			
$Z \leq 1/2t$	Not over viewing area	$x \leq 1/8a$																			
$1/2t < z \leq 2t$	Not exceed 1/3k	$x \leq 1/8a$																			
	Glass crack	<p>Symbols : x: Chip length y: Chip width z: Chip thickness k: Seal width t: Glass thickness a: OLED side length L: Electrode pad length 6.2 Protrusion over terminal : 6.2.1 Chip on electrode pad :</p>  <table border="1" data-bbox="406 1780 1292 1870"> <tr> <td>y: Chip width</td> <td>x: Chip length</td> <td>z: Chip thickness</td> </tr> <tr> <td>$y \leq 0.5\text{mm}$</td> <td>$x \leq 1/8a$</td> <td>$0 < z \leq t$</td> </tr> </table>	y: Chip width	x: Chip length	z: Chip thickness	$y \leq 0.5\text{mm}$	$x \leq 1/8a$	$0 < z \leq t$	2.5												
y: Chip width	x: Chip length	z: Chip thickness																			
$y \leq 0.5\text{mm}$	$x \leq 1/8a$	$0 < z \leq t$																			

NO	Item	Criterion	AQL										
06	Glass crack	<p>6.2.2 Non-conductive portion:</p> <table border="1" data-bbox="461 689 1321 770"> <tr> <td>y: Chip width</td> <td>x: Chip length</td> <td>z: Chip thickness</td> </tr> <tr> <td>$y \leq L$</td> <td>$x \leq 1/8a$</td> <td>$0 < z \leq t$</td> </tr> </table> <p>⊙ If the chipped area touches the ITO terminal, over 2/3 of the ITO must remain and be inspected according to electrode terminal specifications.</p> <p>⊙ If the product will be heat sealed by the customer, the alignment mark not be damaged.</p> <p>6.2.3 Substrate protuberance and internal crack.</p> <table border="1" data-bbox="791 1043 1286 1124"> <tr> <td>y: width</td> <td>x: length</td> </tr> <tr> <td>$y \leq 1/3L$</td> <td>$x \leq a$</td> </tr> </table>	y: Chip width	x: Chip length	z: Chip thickness	$y \leq L$	$x \leq 1/8a$	$0 < z \leq t$	y: width	x: length	$y \leq 1/3L$	$x \leq a$	2.5
y: Chip width	x: Chip length	z: Chip thickness											
$y \leq L$	$x \leq 1/8a$	$0 < z \leq t$											
y: width	x: length												
$y \leq 1/3L$	$x \leq a$												
07	Cracked glass	The OLED with extensive crack is not acceptable.	2.5										
08	Backlight elements	<p>8.1 Illumination source flickers when lit.</p> <p>8.2 Spots or scratched that appear when lit must be judged. Using OLED spot, lines and contamination standards.</p> <p>8.3 Backlight doesn't light or color wrong.</p>	<p>0.65</p> <p>2.5</p> <p>0.65</p>										
09	Bezel	<p>9.1 Bezel may not have rust, be deformed or have fingerprints, stains or other contamination.</p> <p>9.2 Bezel must comply with job specifications.</p>	<p>2.5</p> <p>0.65</p>										

NO	Item	Criterion	AQL
10	PCB , COB	10.1 COB seal may not have pinholes larger than 0.2mm or contamination.	2.5
		10.2 COB seal surface may not have pinholes through to the IC.	2.5
		10.3 The height of the COB should not exceed the height indicated in the assembly diagram.	0.65
		10.4 There may not be more than 2mm of sealant outside the seal area on the PCB. And there should be no more than three places.	2.5
		10.5 No oxidation or contamination PCB terminals.	2.5
		10.6 Parts on PCB must be the same as on the production characteristic chart. There should be no wrong parts, missing parts or excess parts.	0.65
		10.7 The jumper on the PCB should conform to the product characteristic chart.	0.65
		10.8 If solder gets on bezel tab pads, OLED pad, zebra pad or screw hold pad, make sure it is smoothed down.	2.5
11	Soldering	11.1 No un-melted solder paste may be present on the PCB.	2.5
		11.2 No cold solder joints, missing solder connections, oxidation or icicle.	2.5
		11.3 No residue or solder balls on PCB.	2.5
		11.4 No short circuits in components on PCB.	0.65
12	General appearance	12.1 No oxidation, contamination, curves or, bends on interface Pin (OLB) of TCP.	2.5
		12.2 No cracks on interface pin (OLB) of TCP.	0.65
		12.3 No contamination, solder residue or solder balls on product.	2.5
		12.4 The IC on the TCP may not be damaged, circuits.	2.5
		12.5 The uppermost edge of the protective strip on the interface pin must be present or look as if it cause the interface pin to sever.	2.5
		12.6 The residual rosin or tin oil of soldering (component or chip component) is not burned into brown or black color.	2.5
		12.7 Sealant on top of the ITO circuit has not hardened.	2.5
		12.8 Pin type must match type in specification sheet.	0.65
		12.9 OLED pin loose or missing pins.	0.65
		12.10 Product packaging must the same as specified on packaging specification sheet.	0.65
		12.11 Product dimension and structure must conform to product specification sheet.	0.65

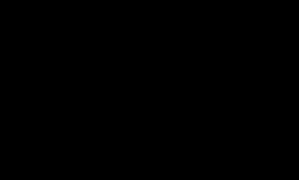
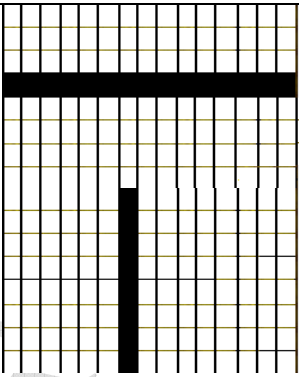
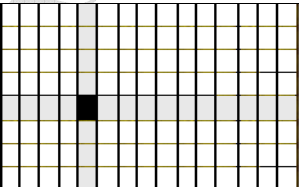
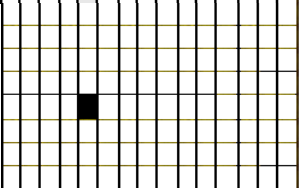
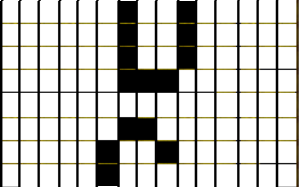
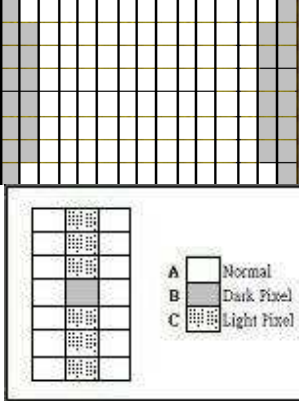

Check Item	Classification	Criteria
No Display	Major	
Missing Line	Major	
Pixel Short	Major	
Darker Short	Major	
Wrong Display	Major	
Un-uniform $B/A \times 100\% < 70\%$ $A/C \times 100\% < 70\%$	Major	

11. Precautions in use of OLED Modules

Modules

- (1) Avoid applying excessive shocks to module or making any alterations or modifications to it.
- (2) Don't make extra holes on the printed circuit board, change the components or modify its shape of OLED display module.
- (3) Don't disassemble the OLED display module.
- (4) Do not apply input signals while the logic power is off.
- (5) Don't operate it above the absolute maximum rating.
- (6) Don't drop, bend or twist OLED display module.
- (7) Soldering: only to the I/O terminals.
- (8) Hot-Bar FPC soldering condition: 280~350C, less than 5 seconds.
- (9) Raystar has the right to change the passive components (Resistors, capacitors and other passive components will have different appearance and color caused by the different supplier.) and change the PCB Rev. (In order to satisfy the supplying stability, management optimization and the best product performance...etc, under the premise of not affecting the electrical characteristics and external dimensions, Raystar have the right to modify the version.)
- (10) Raystar has the right to upgrade or modify the product function.

11.1. Handling Precautions

- (1) Since the display panel is being made of glass, do not apply mechanical impacts such as dropping from a high position.
- (2) If the display panel is broken by some accident and the internal organic substance leaks out, be careful not to inhale nor lick the organic substance.
- (3) If pressure is applied to the display surface or its neighborhood of the OLED display module, the cell structure may be damaged. So, be careful not to apply pressure to these sections.
- (4) The polarizer covering the surface of the OLED display module is soft and easily scratched.
- (5) When the surface of the polarizer of the OLED display module has soil, clean the surface. It takes advantage by using following adhesion tape.
 - * Scotch Mending Tape No. 810 or an equivalentNever try to breathe upon the soiled surface nor wipe the surface using cloth containing solvent such as ethyl alcohol, since the surface of the polarizer will become cloudy. Also, pay attention that the following liquid and solvent may spoil the polarizer:
 - * Water
 - * Ketone
 - * Aromatic Solvents
- (6) Protection film is being applied to the surface of the display panel and removes the protection film before assembling it. At this time, if the OLED display module has been stored for a long period of time, residue adhesive material of the protection film may remain on the surface of the display panel after removed of the film. In such case, remove the residue material by the method introduced in the above Section 5.
- (7) Do not touch the following sections whenever possible while handling the OLED display modules.
 - * Pins and electrodes
 - * Pattern layouts such as the TCP & FPC
- (8) Hold OLED display module very carefully when placing OLED display module into the

System housing. Do not apply excessive stress or pressure to OLED display module. And, do not over bend the film with electrode pattern layouts. These stresses will influence the display performance. Also, secure sufficient rigidity for the outer cases.

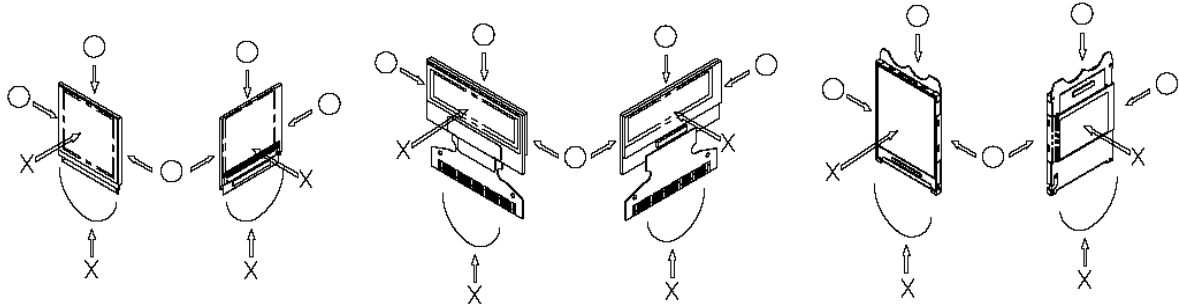

- (9) Do not apply stress to the LSI chips and the surrounding molded sections.
- (10) Pay sufficient attention to the working environments when handing OLED display modules to prevent occurrence of element breakage accidents by static electricity.
 - * Be sure to make human body grounding when handling OLED display modules.
 - * Be sure to ground tools to use or assembly such as soldering irons.
 - * To suppress generation of static electricity, avoid carrying out assembly work under dry environments.
 - * Protective film is being applied to the surface of the display panel of the OLED display module. Be careful since static electricity may be generated when exfoliating the protective film.

11.2. Storage Precautions

- (1) When storing OLED display modules, put them in static electricity preventive bags to avoid be directly exposed to sun or lights of fluorescent lamps. (We recommend you to store these modules in the packaged state when they were shipped from Raystar. At that time, be careful not to let water drops adhere to the packages or bags.)
- (2) When the OLED display module is being dewed or when it is placed under high temperature or high humidity environments, the electrodes may be corroded if electric current is applied. Please store it in clean environment.

11.3. Designing Precautions

- (1) The absolute maximum ratings are the ratings which cannot be exceeded for OLED display module, and if these values are exceeded, OLED display module may be damaged.
- (2) To prevent occurrence of malfunctioning by noise, pay attention to satisfy the VIL and VIH specification and to make the signal line cable as short as possible.
- (3) We recommend you to install excess current preventive unit (fuses, etc.) to the power circuit (VDD / VCC). (Recommend value: 0.5A)
- (4) Pay sufficient attention to avoid occurrence of mutual noise interference with the nearby devices.
- (5) As for EMI, take necessary measures on the equipment side basically.
- (6) If the power supplied to the OLED display module is forcibly shut down by such errors as taking out the main battery while the OLED display panel is in operation, we cannot guarantee the quality of this OLED display module.
 - * Connection (contact) to any other potential than the above may lead to rupture of the IC.

- (7) If this OLED driver is exposed to light, malfunctioning may occur and semiconductor elements may change their characteristics.
- (8) The internal status may be changed, if excessive external noise enters into the module. Therefore, it is necessary to take appropriate measures to suppress noise generation or to protect module from influences of noise on the system design.
- (9) We recommend you to make periodical refreshment of the operation statuses (re-setting of the commands and re-transference of the display data) to cope with catastrophic noise.
- (10) It's pretty common to use "Screen Saver" to extend the lifetime and Don't use the same image for long time in real application. When an OLED display module is operated for a long of time with fixed pattern, an afterimage or slight contrast deviation may occur.
- (11) The limitation of FPC and Film bending.

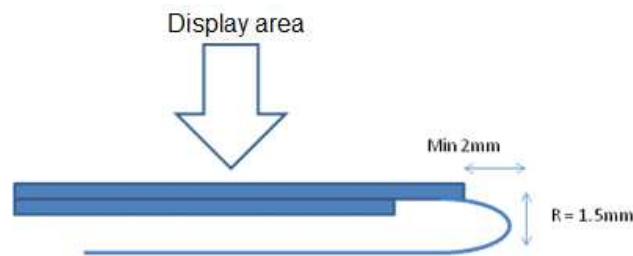

- (12) The module should be fixed balanced into the housing, or the module may be twisted.

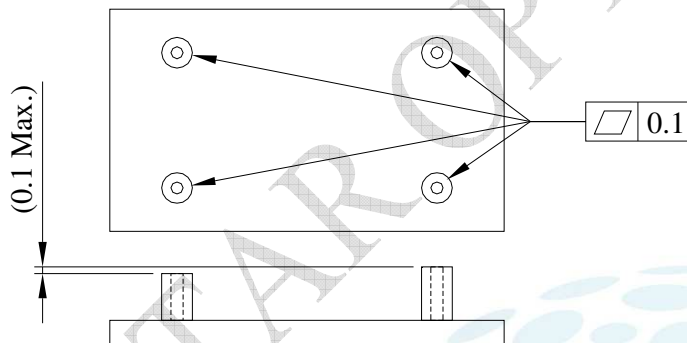

- (13) Please heat up a little the tape sticking on the components when removing it; otherwise the components might be damaged.

11.4. Precautions when disposing of the OLED display modules

- (1) Request the qualified companies to handle industrial wastes when disposing of the OLED display modules. Or, when burning them, be sure to observe the environmental and hygienic laws and regulations.

Module Sample Estimate Feedback Sheet

Module Number : _____

1 、 Panel Specification :

1. Panel Type :	<input type="checkbox"/> Pass	<input type="checkbox"/> NG , _____
2. Numbers of Pixel :	<input type="checkbox"/> Pass	<input type="checkbox"/> NG , _____
3. View Area :	<input type="checkbox"/> Pass	<input type="checkbox"/> NG , _____
4. Active Area :	<input type="checkbox"/> Pass	<input type="checkbox"/> NG , _____
5. Emitting Color :	<input type="checkbox"/> Pass	<input type="checkbox"/> NG , _____
6. Uniformity :	<input type="checkbox"/> Pass	<input type="checkbox"/> NG , _____
7. Operating Temperature :	<input type="checkbox"/> Pass	<input type="checkbox"/> NG , _____
8. Storage Temperature :	<input type="checkbox"/> Pass	<input type="checkbox"/> NG , _____
9. Others :	_____	

2 、 Mechanical Specification :

1. PCB Size :	<input type="checkbox"/> Pass	<input type="checkbox"/> NG , _____
2. Frame Size :	<input type="checkbox"/> Pass	<input type="checkbox"/> NG , _____
3. Material of Frame :	<input type="checkbox"/> Pass	<input type="checkbox"/> NG , _____
4. Connector Position :	<input type="checkbox"/> Pass	<input type="checkbox"/> NG , _____
5. Fix Hole Position :	<input type="checkbox"/> Pass	<input type="checkbox"/> NG , _____
6. Thickness of PCB :	<input type="checkbox"/> Pass	<input type="checkbox"/> NG , _____
7. Height of Frame to PCB :	<input type="checkbox"/> Pass	<input type="checkbox"/> NG , _____
8. Height of Module :	<input type="checkbox"/> Pass	<input type="checkbox"/> NG , _____
9. Others :	<input type="checkbox"/> Pass	<input type="checkbox"/> NG , _____

3 、 Relative Hole Size :

1. Pitch of Connector :	<input type="checkbox"/> Pass	<input type="checkbox"/> NG , _____
2. Hole size of Connector :	<input type="checkbox"/> Pass	<input type="checkbox"/> NG , _____
3. Mounting Hole size :	<input type="checkbox"/> Pass	<input type="checkbox"/> NG , _____
4. Mounting Hole Type :	<input type="checkbox"/> Pass	<input type="checkbox"/> NG , _____
5. Others :	<input type="checkbox"/> Pass	<input type="checkbox"/> NG , _____

>> **Go to page 2** <<



Module Number : _____		
4 、 Electronic Characteristics of Module :		
1.Input Voltage :	<input type="checkbox"/> Pass	<input type="checkbox"/> NG , _____
2.Supply Current :	<input type="checkbox"/> Pass	<input type="checkbox"/> NG , _____
3.Driving Voltage for OLED :	<input type="checkbox"/> Pass	<input type="checkbox"/> NG , _____
4.Contrast for OLED :	<input type="checkbox"/> Pass	<input type="checkbox"/> NG , _____
5.Negative Voltage Output :	<input type="checkbox"/> Pass	<input type="checkbox"/> NG , _____
6.Interface Function :	<input type="checkbox"/> Pass	<input type="checkbox"/> NG , _____
7.ESD test :	<input type="checkbox"/> Pass	<input type="checkbox"/> NG , _____
8.Others :	<input type="checkbox"/> Pass	<input type="checkbox"/> NG , _____
5 、 Summary :		
<p>Sales signature : _____</p> <p>Customer Signature : _____</p> <p style="text-align: right;">Date : / /</p>		